

# HIGH-PRESSURE RELIEF VALVES H-900HP SERIES



**FEATURES**

- H-900HP is available as CE/PED products.
- 316St.St. Construction
- Service up to 6000 psi
- Set Pressure from 50 psig to 6000 psig (3.50 to 414 bar)
- Identifying colored springs for each pressure range
- Replaceable springs for a variable pressure range
- Available in all pipe threads and LET-LOK connectors
- Sizes: 1/4" or 6mm

**GENERAL**

H-900 HP is a series of relief valves for high-pressure service. The valve is normally closed. It will open when the system pressure reaches the set level. It will re-close when the system pressure falls below the set level.

MATERIALS OF CONSTRUCTION			
Item No.	Components	Qty.	Valve Body Material
1	Cap Plug	1	PTFE
2	Label	1	Polyester
3	Adjustment Cap	1	St.St 316
4	Spring	1	St.St. 302,17-7PH
5	Lower Spring Button	1	St.St 316
6	Locking Nut	1	St.St 316
7	Bonnet	1	St.St 316
8	O-Ring	1	Viton® (Fluorocarbon)
9	Quad Ring	1	Viton® (Fluorocarbon)
10	Retaining Ring	1	PH15-7Mo
11	Poppet	1	St.St 316
12	Clamps Screw	1	St.St 316
13	O-Ring	1	Viton® (Fluorocarbon)
14	Insert	1	St.St 316
15	Body	1	St.St 316

STANDARD CONFIGURATION DIMENSIONS										
Description	Connection / size		Dimensions							
	inlet	outlet	A		B		C		D	
			mm	inch	mm	inch	mm	inch	mm	inch
H-900HP	1/4 LET-LOK®	1/4 LET-LOK®	37	1.45	39	1.53	50	1.97	96.0	3.78
H-900HP	6MM LET-LOK®	6MM LET-LOK®	37	1.45	39	1.53	50	1.97	96.0	3.78
H-985HP	1/4 Male NPT	1/4 Female NPT	32	1.26	30	1.18	40	1.57	88.6	3.49
H-995HP	1/4 Male NPT	1/4 LET-LOK®	32	1.26	39	1.53	50	1.97	88.6	3.49

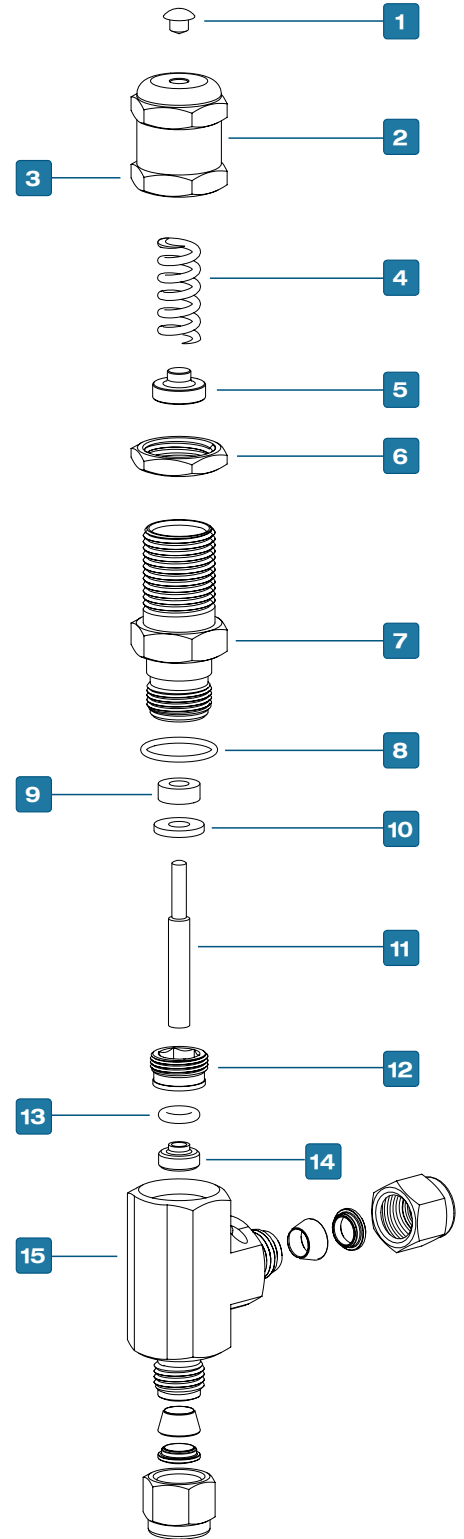
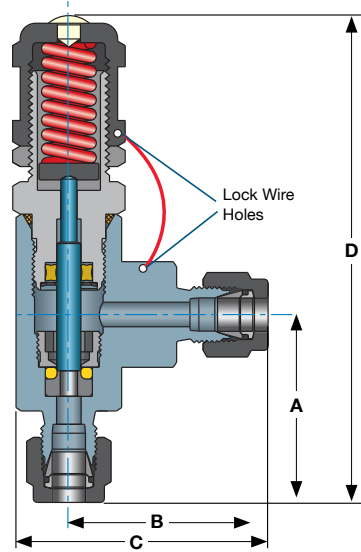

**CLEANING AND PACKAGING**

HAM-LET H-900HP Relief Valves are treated with the HAM-LET Passivation Cleaning and Packaging (Procedure 8075). Oxygen Cleaning and Packaging (Procedure 8055) is available as an option.

**TESTING**

The HAM-LET H-900HP Relief Valves design has been tested for Proof and Burst. Every H-900HP Relief Valve is factory tested for proper set and re-sealing performance.

NOMINAL CRACKING PRESSURE RANGE			
psig	Bars	Spring Designator	Color
50-350	3.4 - 24	A	White
350-750	24 - 51.5	B	Blue
750-1500	51.5 - 103	C	Gold
1500-2250	103 - 155	D	Turquoise
2250-3000	155 - 206	E	Green
3000-4000	206 - 275	F	Red
4000-5000	275 - 344	G	Silver
5000-6000	344 - 413	H	Black

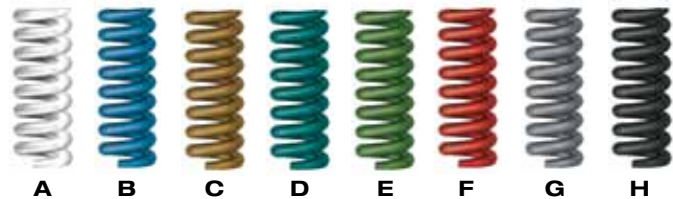

PRESSURE TEMPERATURE RATING				
Series	H-900HP Size: 1/4"			
	Viton®	Buna N	Neoprene	EPDM
TEMP °C (°F)	MAX SET PRESSURE psig (bar)			
-40 (-40)	-	-	-	-
-34 (-30)				
-23 (-10)				
-18 (0)				
-12 (10)				
-4 (25)	6000 (413)	6000 (413)	6000 (413)	-
-1 (30)				
10 (50)				
65 (150)	5600 (386)	5600 (386)	5600 (386)	5600 (386)
93 (200)	5200 (358)	5200 (358)	5200 (358)	5200 (358)
121 (250)	4900 (338)	4900 (338)	4900 (338)	4900 (338)
135 (275)	-	-	4700 (324)	-
148 (300)				

**SETTING AND RESEALING PRESSURE**

- Upstream set pressure is the first indicator of flow process. Every pressure relief after the first is repeatable within a deviation of 5% at room temperature.
- Blocked upstream set pressure is the first indicator of a stopped flow process and is always lower than the set pressure.

H-900HP RESEAL PRESSURE		
Series	Test Set Pressure psig (bar)	Min Resealing Pressure as a Percentage of set pressure, %
H-900HP	100 - 200 (6.8 to 13.7)	50
	850 - 1000 (58.5 to 68.9)	84

**FLOW DATA AT 70°F (20°C)**

Orifice in fully open mode is 3.6mm (0.14 inch)



**SPRING 50-350psig**



**SPRING 350-750psig**

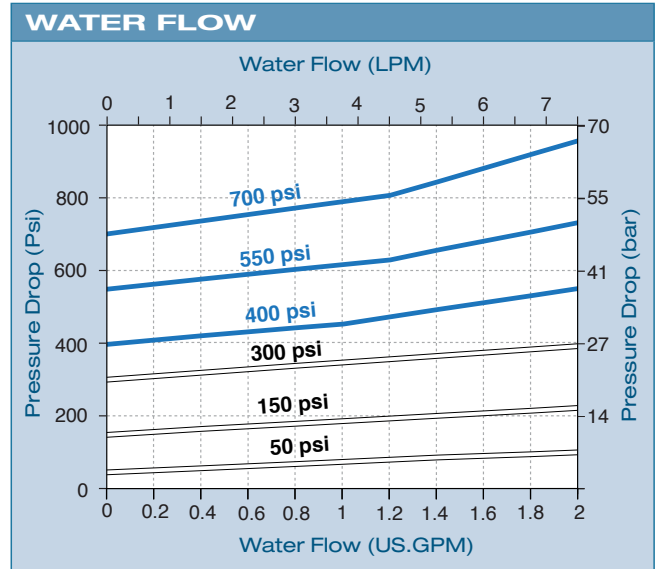
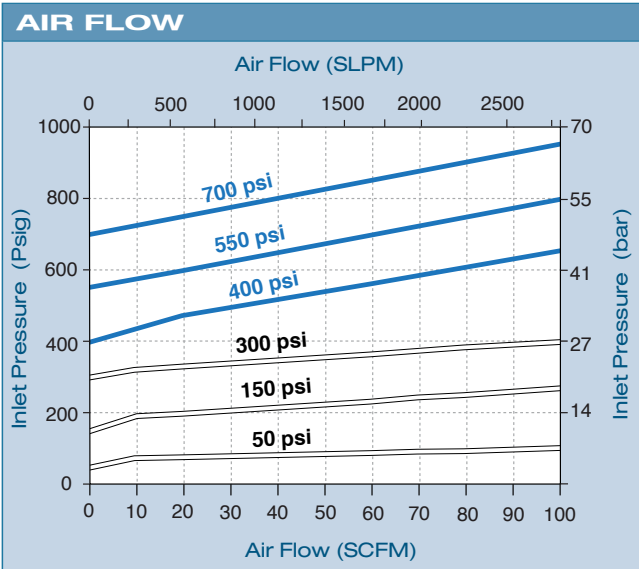

**SPRING 750-1500psig**



**SPRING 1500-2250psig**

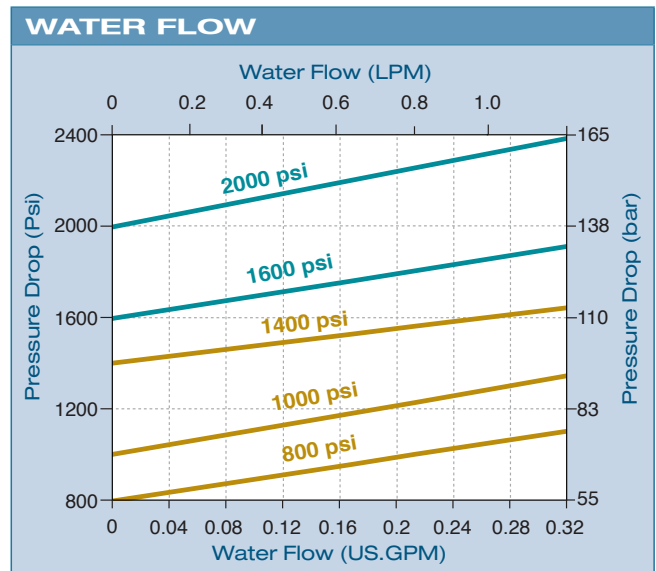
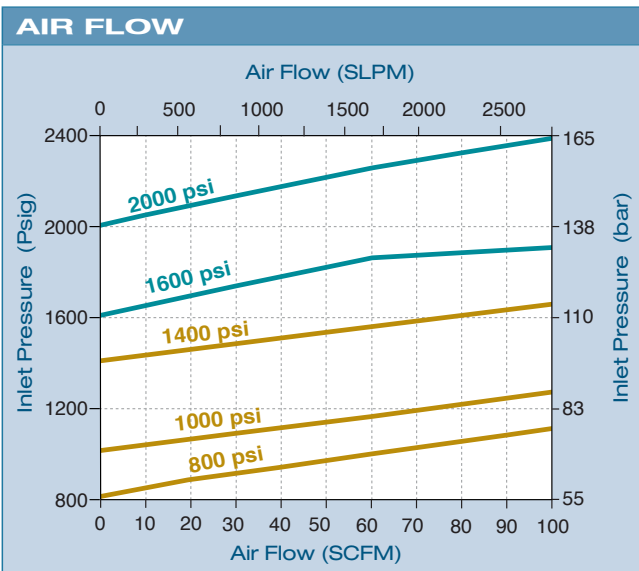

**FLOW DATA AT 70°F (20°C)**

Orifice in fully open mode is 3.6mm (0.14 inch)



**SPRING 2250-3000psig**



**SPRING 3000-4000psig**

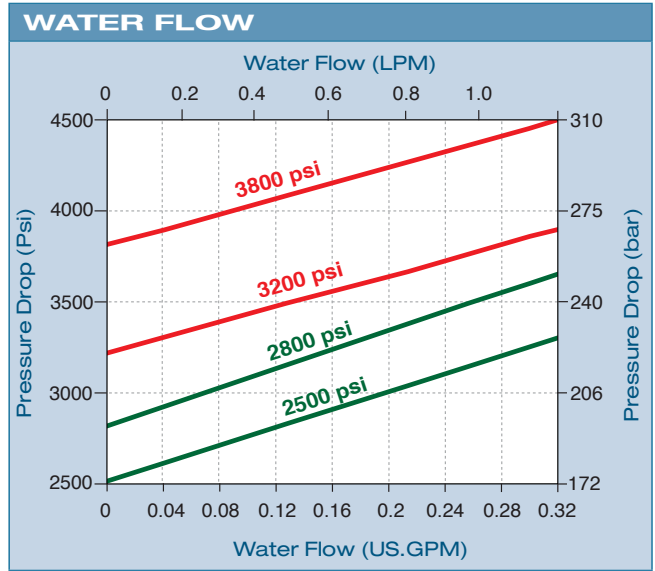
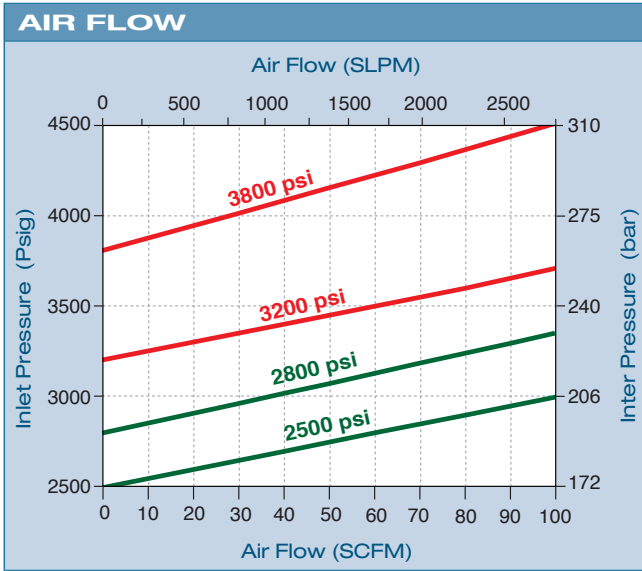

**SPRING 4000-5000psig**



**SPRING 5000-6000psig**

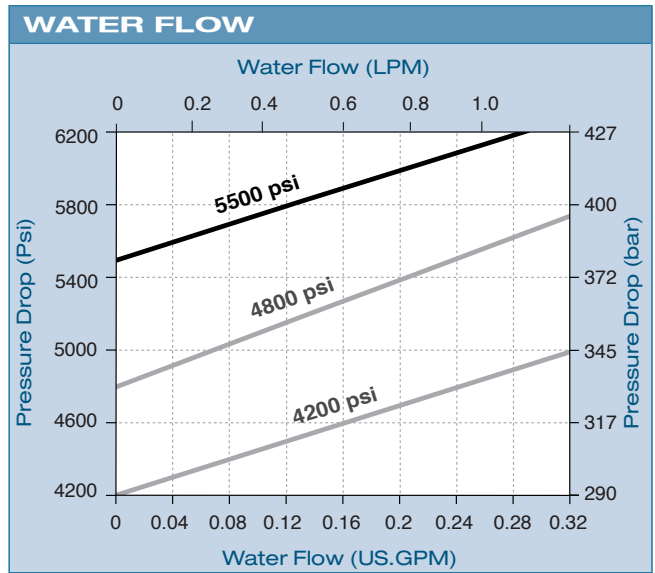
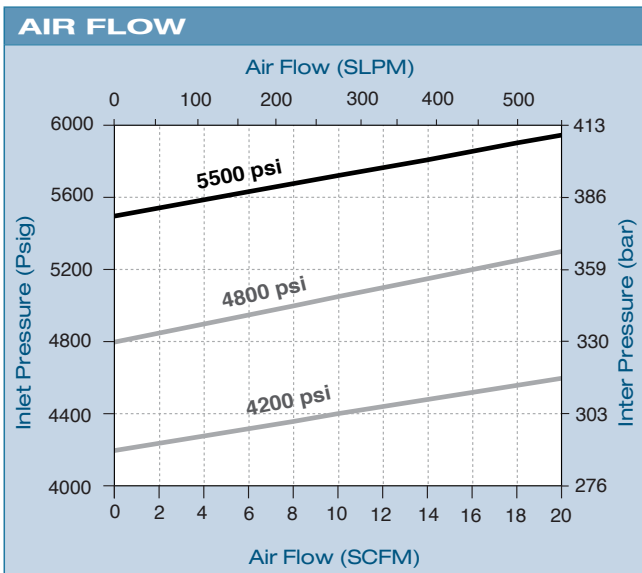

**APPLICATIONS**

H-900HP relief valves gradually open when pressure increases. As such, they are not certified to ASME due to not having capacity rating at a given pressure rise (accumulation).

**OPERATION**

H-900HP relief valves open when system pressure gets to the set pressure and close when system pressure drops below the set pressure.

**Warning**

- Valves that were not actuated for some time may contain pressure higher than the set pressure.
- System designer and users shall determine what system applications require using relief valves for meeting specific safety codes and which valves conform to such codes.

**H-900HP ORDERING INFORMATION**

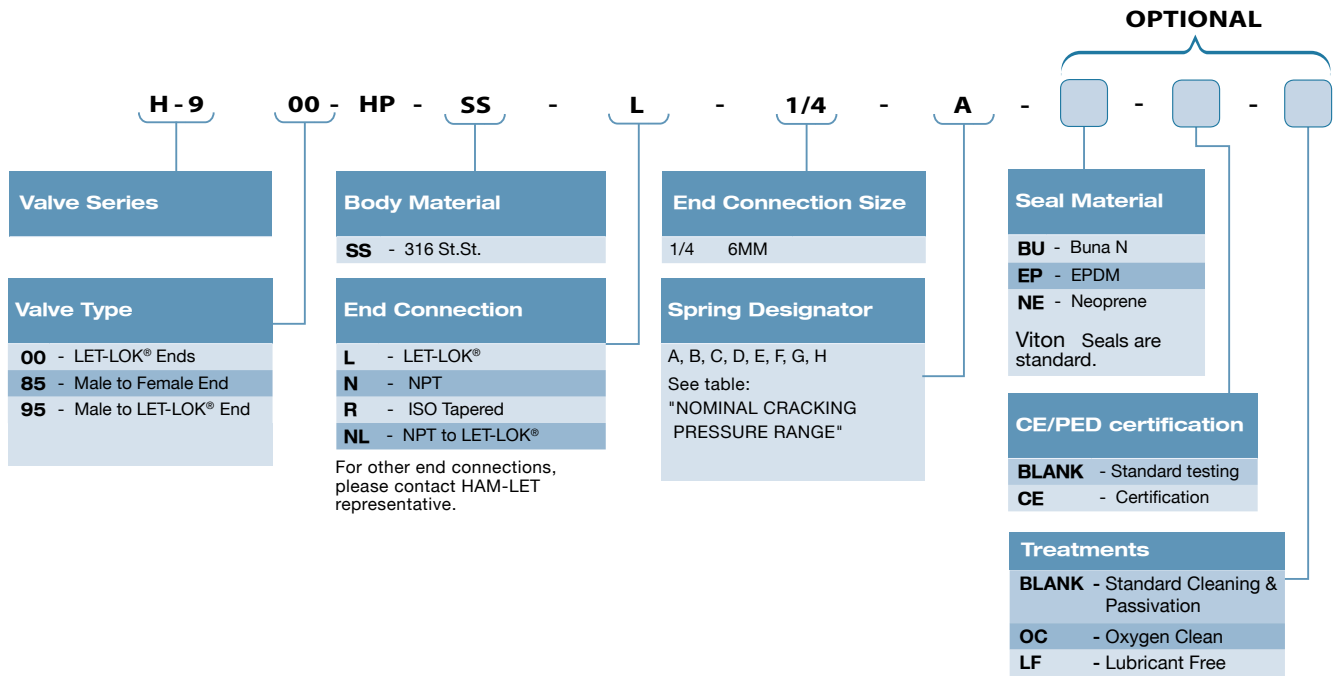

**SPRING KIT**

Included:  
Spring (specific to desired set pressure range) and label.

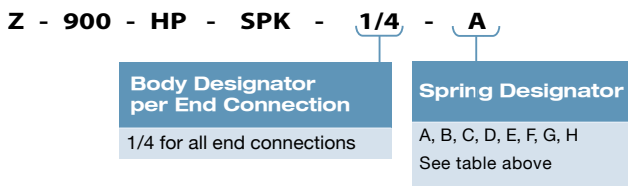

**SEAL KIT**

Included: O-Rings and label

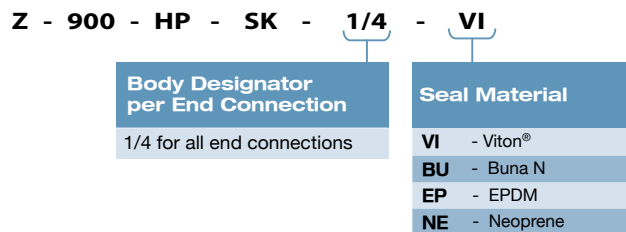

**Warning**-Select the right component for safety's sake: The total design of the system must be taken into consideration when selecting components in order to ensure that your HAM-LET products provide safe, trouble-free operation. It is the responsibility of the system designer and the user to consider the compatibility of the materials, of the components and system, the function of the component, appropriate ratings and to ensure proper installation, operation and maintenance. Improper selection or use of products can cause property damage or personal injury, in respect of which the system designer and/or the user shall be solely liable and responsible.

Viton® - TM DuPont

H-900HP, Rev.07, August 2010