

# RELIEF VALVES

## H-900 SERIES

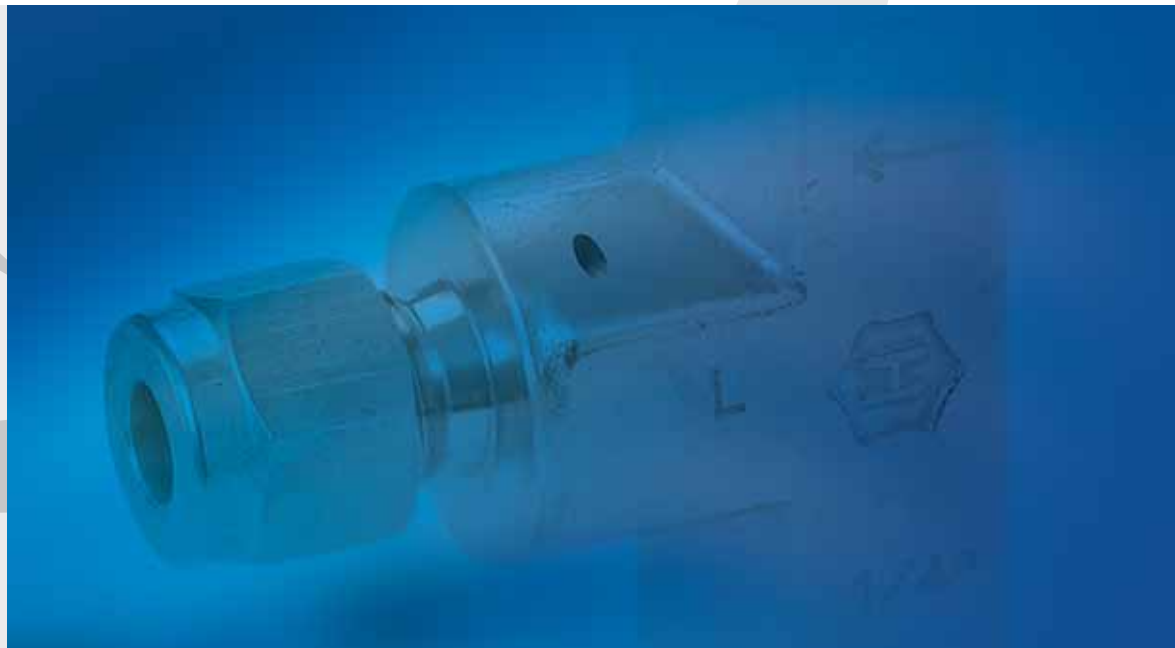

**FEATURES**

- H-900 is available as CE/PED products.
- 316St.St. Construction
- Service 10-225 psi
- One spring for all set pressure range
- Available in all pipe threads and LET-LOK® connectors
- Sizes: 1/4" or 6mm

**GENERAL**

The H-900 series is a relief valve for low pressure service. The valve is normally closed. It will open when system pressure reaches the set level. It will re-close when the system pressure falls below the set level.

**MATERIALS OF CONSTRUCTION**

Item No.	Components	Qty.	Valve Body Material
1	Cap Plug	1	Polypropylene
2	Adjustment Cap	1	St.St. 316
3	Cap Lable	1	Polyester
4	Locking Nut	1	St.St. 316
5	Upper Spring Button	1	St.St. 316
6	Spring	1	St.St. 302
7	Lower Spring Button	1	St.St. 316
8	Bonnet	1	St.St. 316
9	O-ring	1	Viton® (Fluorocarbon)
10	O-ring	1	Viton® (Fluorocarbon)
11	Retaining Ring	1	PH15 - 7 Mo
12	Stem	1	St.St. 316
13	Poppet	1	St.St. 316 Bonded with Viton®
14	Insert	1	St.St. 316
15	Packing	1	PTFE
16	Ring	1	St.St. 316
17	Body	1	St.St. 316

**STANDARD CONFIGURATION DIMENSIONS**

Description	Connection / size		Orifice		Dimensions							
	Inlet	Outlet			A		B		C		D	
	mm	inch	mm	inch	mm	inch	mm	inch	mm	inch	mm	inch
H-900	1/4 LET-LOK®	1/4 LET-LOK®	4.8	0.19	37	1.45	39	1.53	50	1.97	96	3.78
H-900	6MM LET-LOK®	6MM LET-LOK®			37	1.45	39	1.53	50	1.97	96	3.78
H-985	1/4 Male NPT	1/4 Female NPT			32	1.26	30	1.18	40	1.57	88.6	3.49
H-995	1/4 Male NPT	1/4 LET-LOK®			32	1.26	39	1.53	50	1.97	88.6	3.49

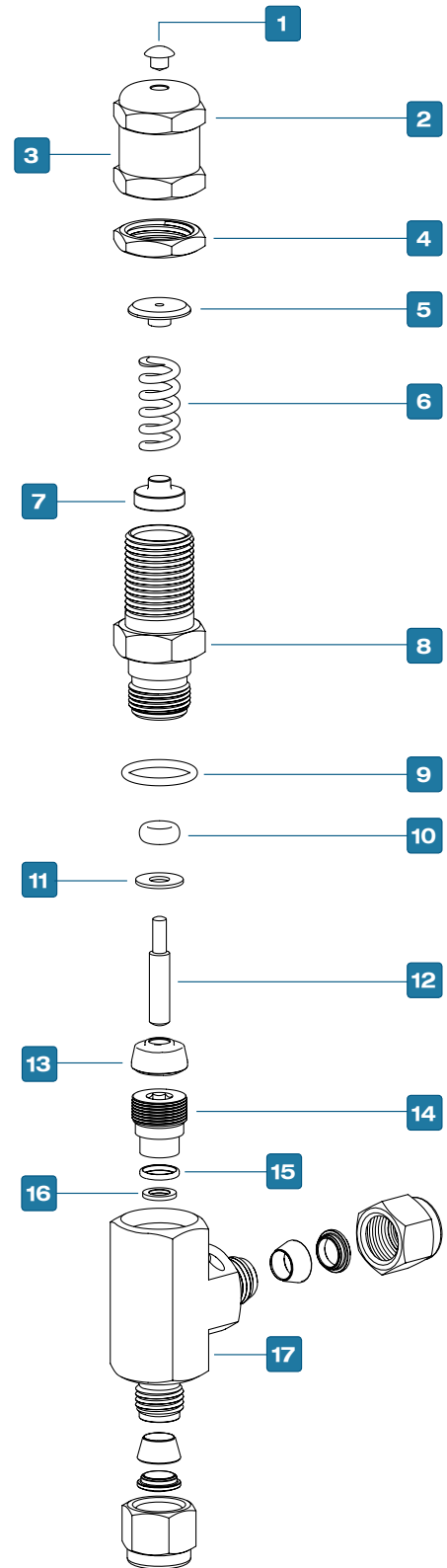
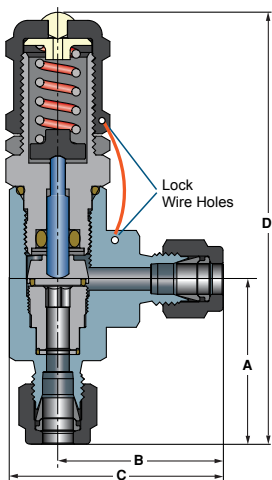

**CLEANING AND PACKAGING**

HAM-LET H-900 Relief Valve is treated with Passivation Cleaning and Packaging (Procedure 8075). Oxygen Cleaning and Packaging (Procedure 8055) is available as an option.

**TESTING**

The HAM-LET H-900 Relief Valve designs have been tested for Proof and Burst. Every H-900 Relief Valve is factory tested for proper set and resealing performance.

**SETTING AND RESEALING PRESSURE**

- Upstream set pressure is the first indicator of flow process. Every pressure relief after the first is repeatable within a deviation of 5% at room temperature.
- Blocked upstream set pressure is the first indicator of a stopped flow process and is always lower than the set pressure.
- Calculation of set pressure valve design demands back pressure consideration as the system back pressure increases the set pressure. To balance the system the back pressure must be multiplied by 0.8 and the result shall be subtracted from the required set pressure.

PRESSURE TEMPERATURE RATING				
Series	H-900 Size: 1/4"			
Seal Material	Viton®	Buna N	Neoprene	EPDM
TEMP °C (°F)	MAX SET PRESSURE psig (bar)			
-40 (-40)	-	-	-	225 (15.5)
-34 (-30)	-	-		
-23 (-10)	-			
-18 (0)	225 (15.5)	225 (15.5)	225 (15.5)	
-12 (10)				
-4 (25)				
-1 (30)				
10 (50)				
65 (150)				
93 (200)				
121 (250)				
135 (275)				
148 (300)	-			

**FLOW DATA AT 70°F (20°C)**

Orifice in fully open mode is 4.8mm (0.19 inch)

**SPRING 10-225psig**

H900 RESEAL PRESSURE		
Series	Test Set Pressure psig (bar)	Min Resealing Pressure as a Percentage of set pressure, %
H-900	10 - 20 (0.68 to 1.3)	50
	175 - 225 (12.0 to 15.5)	90

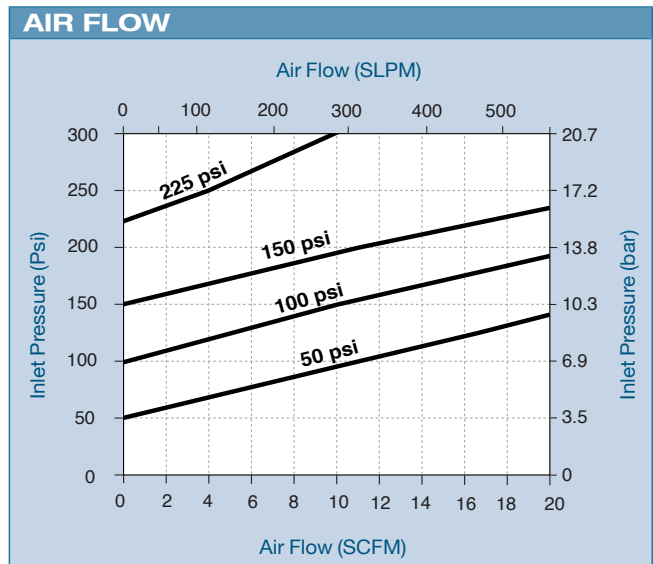
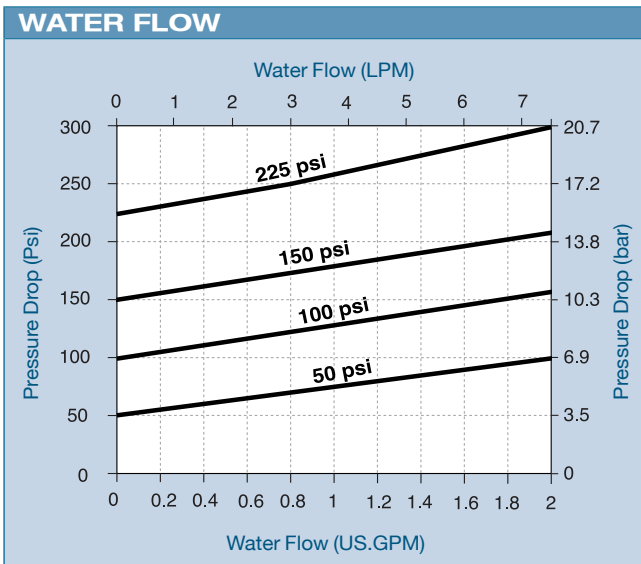

**APPLICATIONS**

H-900 relief valves gradually open when pressure increases. As such, they are not certified to ASME due to not having capacity rating at a given pressure rise (accumulation).

**OPERATION**

H-900 relief valves open when system pressure gets to the set pressure and close when system pressure drops below the set pressure.

**Warnings**

- Valves that were not actuated for some time may contain pressure higher than the set pressure.
- System designer and users shall determine what system applications require using relief valves for meeting specific safety codes and which valves conform to such codes.

**H-900 SERIES ORDERING INFORMATION**

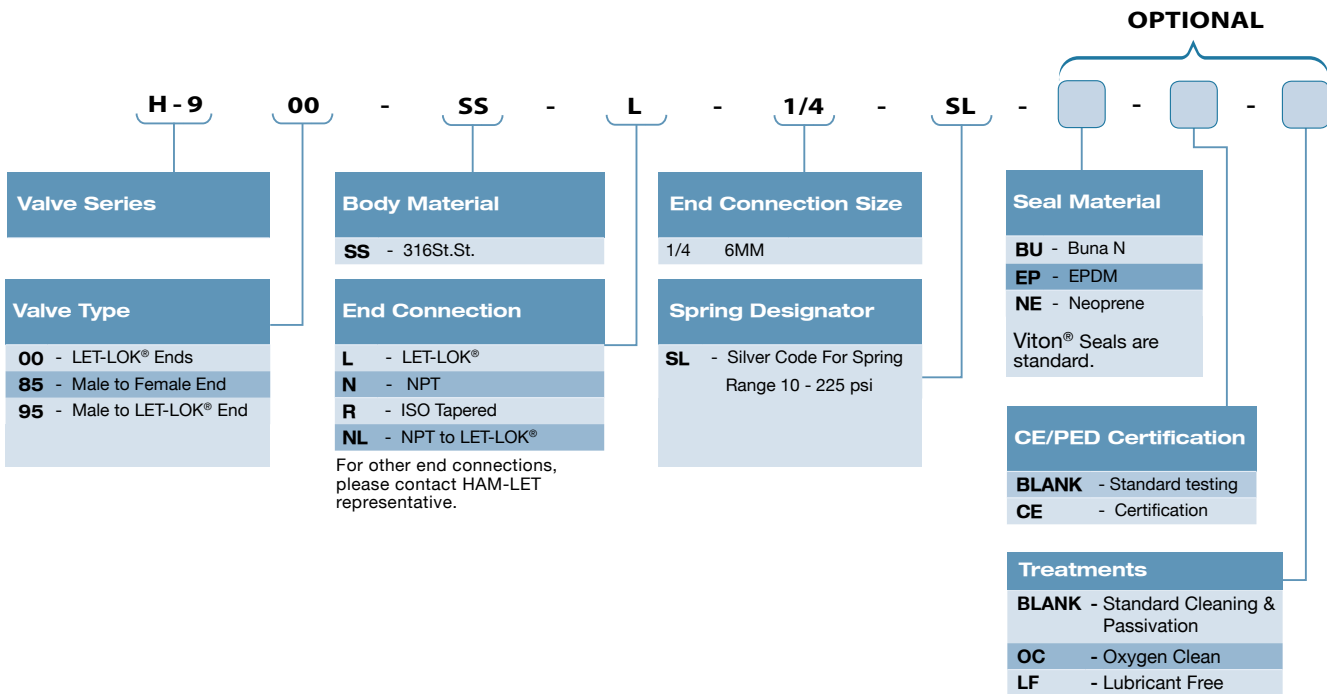

**ORDERING INFORMATION FOR SPARE KITS**

**SPRING KIT**

Includes: Spring, Label, Wire and Lock



**SEAL KIT**

Includes: O-rings, Bonded Poppet and Label

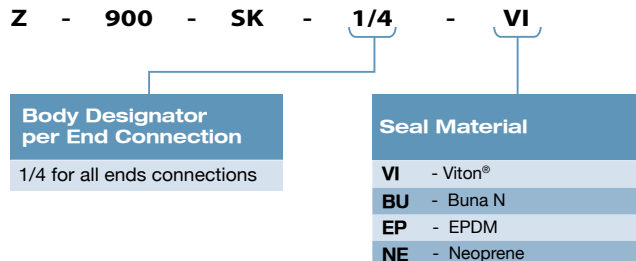

**Warning** Select the right component for safety's sake: The total design of the system must be taken into consideration when selecting components in order to ensure that your HAM-LET products provide safe, trouble-free operation. It is the responsibility of the system designer and the user to consider the compatibility of the materials, of the components and system, the function of the component, appropriate ratings and to ensure proper installation, operation and maintenance. Improper selection or use of products can cause property damage or personal injury, in respect of which the system designer and/or the user shall be solely liable and responsible.